

FRONT COVER 85"

HI-ND Front Cover for professional displays

The front cover is used in environments like retail stores, conference rooms, lobbies often together with menuboards. Our own designed non-visible fasteners makes the product very easy to install. Use your creative ideas and choose a front cover with your own choice of material and color. It is designed for both landscape and portrait mode.



TECHNICAL DRAWING

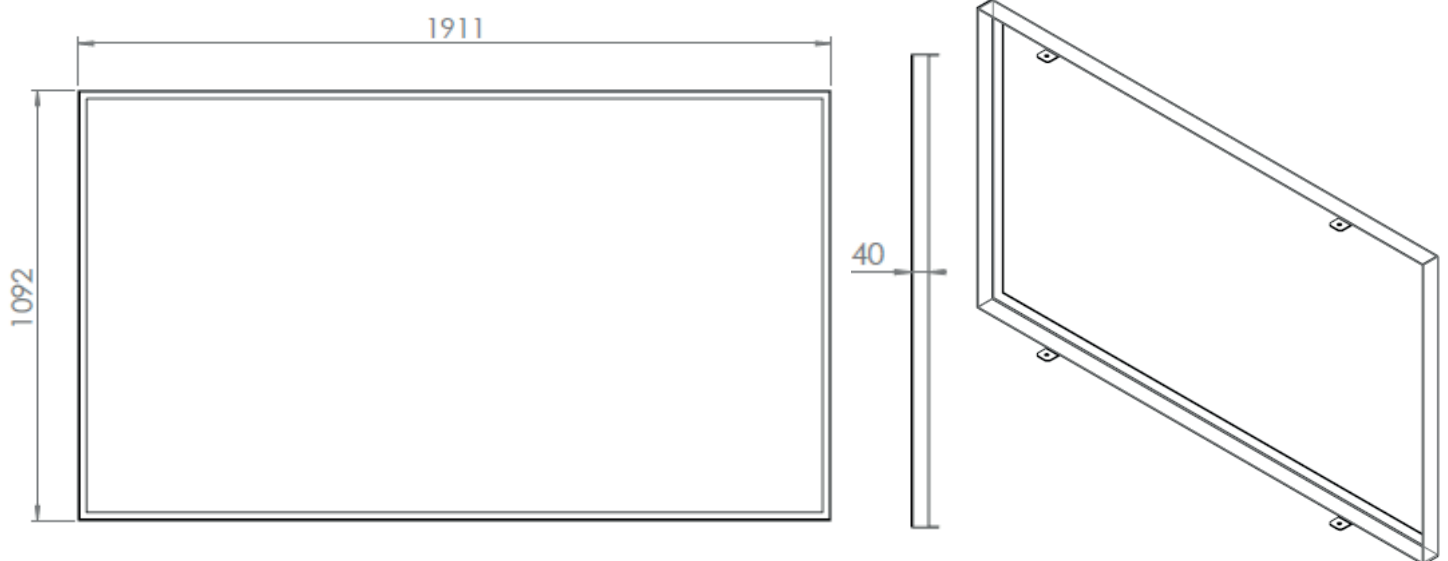

SPECIFICATION

FEATURES

- Both Landscape/Portrait mode
- Easy mounting
- Other materials as brass and stainless steel available

MATERIALS

- Powder coated metal

DISPLAYS

- Designed for Samsung QMC and LG UM5N-E, UH5N-E

POWDER COATING OPTIONS

Black, RAL 9005str

White, RAL 9003str

Custom color upon request

PART NO AND DESCRIPTION

FC8512-0201-01 Front Cover, White, 85"

FC8512-0201-02 Front Cover, Black, 85"